

BUS WINDOW GUIDE FRAMES

24204 0.247 kg/m

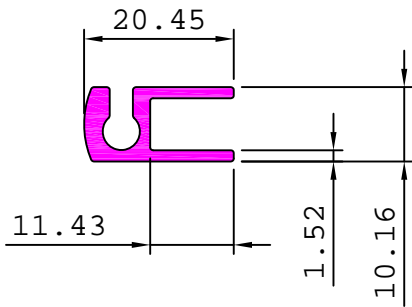

24211 0.148 kg/m

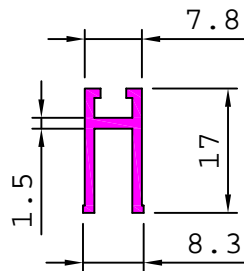

24212 0.171 kg/m

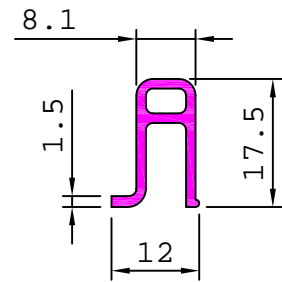

24208 0.592 kg/m

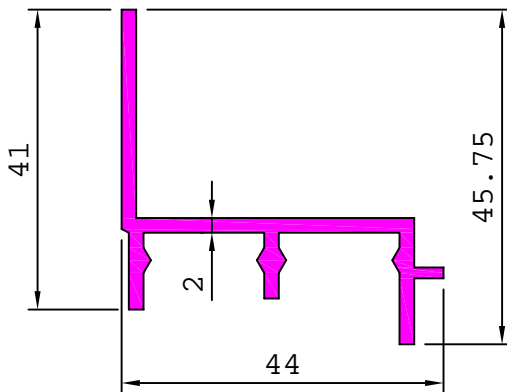

24220 0.687 kg/m

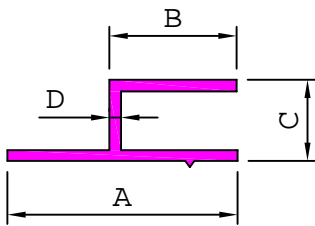
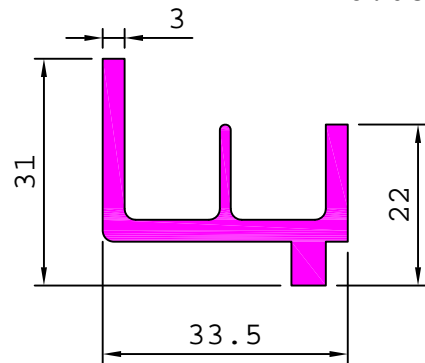

SL. No.	Section No.	A	B	C	D	Weight kg/m
1	24235	29.90	18.00	12.30	0.70	0.112
2	24213	31.00	16.50	11.00	0.84	0.130
3	24214	34.60	19.50	12.70	0.93	0.166

24219 0.243 kg/m

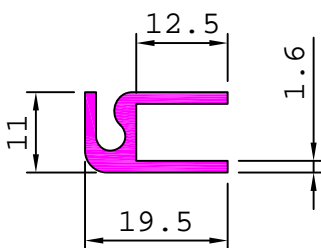

24236 0.092 kg/m

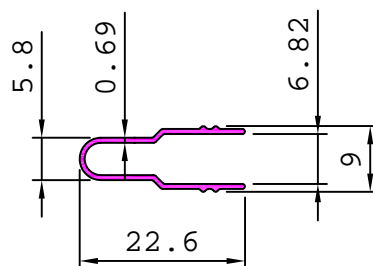

24238 0.172 kg/m

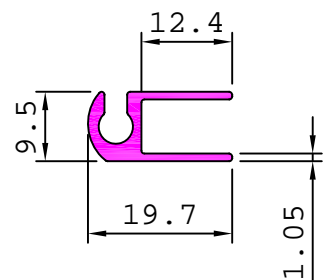

BUS WINDOW GUIDE FRAMES

24221

0.662 kg/m

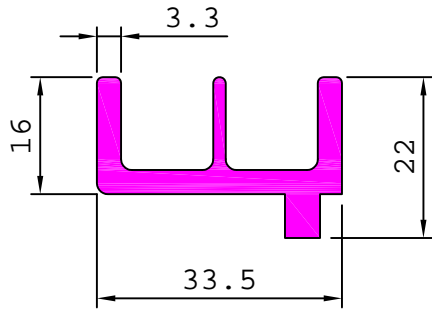

24223

0.478 kg/m

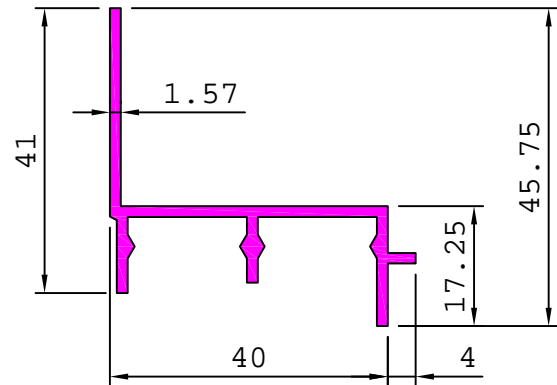

24226

0.686 kg/m

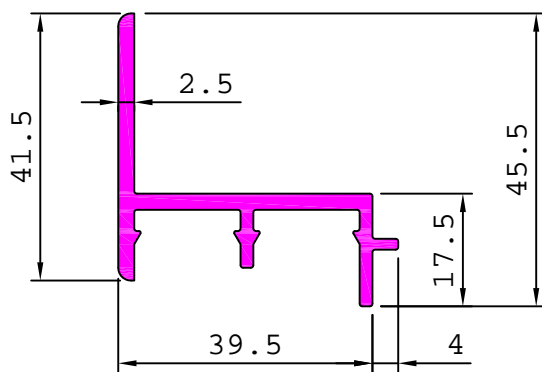

24233

0.580 kg/m

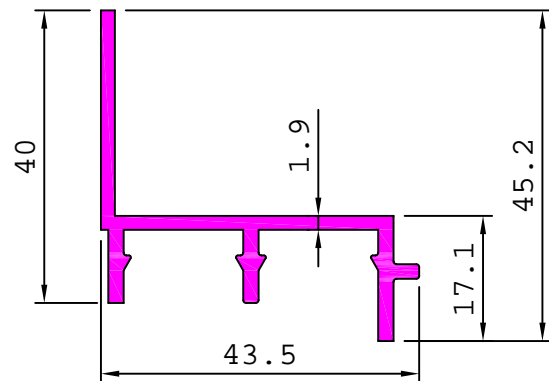

24237

0.414 kg/m

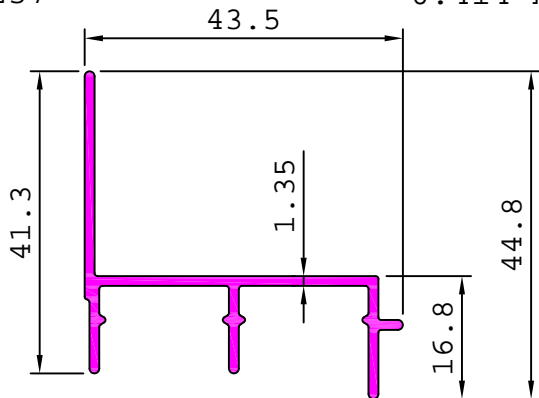

24242

0.895 kg/m

