

LADDERS

FLUTED ROUND TUBES

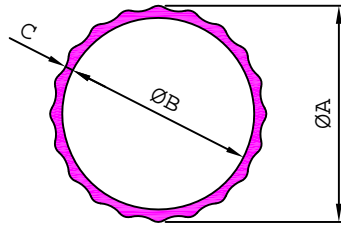

SL. No.	Section No.	ØA	ØB	C	Weight kg/m
1	14904	18.50	16.75	0.67	0.114
2	14907	18.50	17.33	0.38	0.074
3	14913	18.80	16.70	0.70	0.127
4	14901	19.05	16.90	0.70	0.130
5	14910	20.50	17.70	0.90	0.186
6	14909	20.70	19.20	0.52	0.109
7	14915	24.00	22.62	0.49	0.114
8	14903	24.80	22.60	0.70	0.179
9	14916	24.80	22.97	0.67	0.156
10	14906	24.80	23.56	0.416	0.107
11	14921	24.80	22.84	0.58	0.148
12	14902	25.40	20.34	1.83	0.410
13	14914	25.40	22.01	0.93	0.252
14	14912	25.40	22.07	0.90	0.247
15	14908	25.40	22.20	0.79	0.226
16	14917	25.40	22.68	0.60	0.189
17	14919	25.40	20.80	1.60	0.370
18	14905	28.00	25.50	0.80	0.237
19	14911	28.00	26.32	0.63	0.171
20	14918	32.06	27.00	1.83	0.533
21	14920	37.00	33.00	1.50	0.511

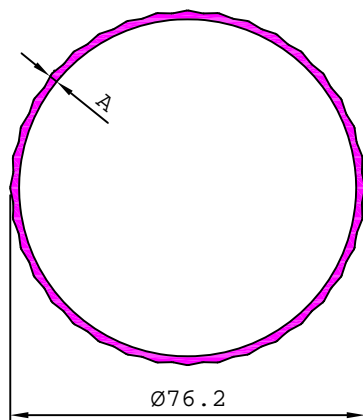

SL. No.	Section No.	A	Weight kg/m
1	22592	1.60	0.839
2	22585	1.90	1.024

22597

0.978 kg/m

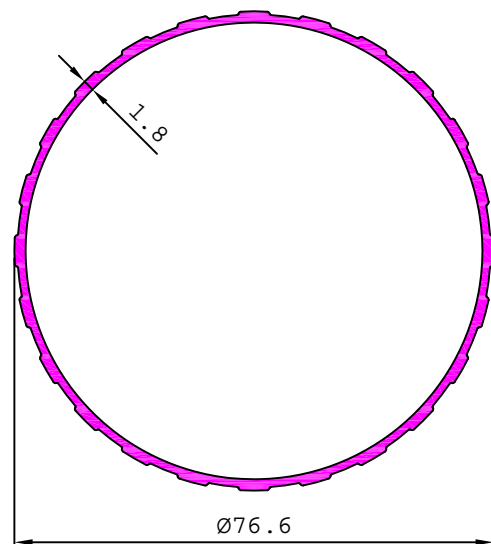

LADDERS

22510

0.769 kg/m

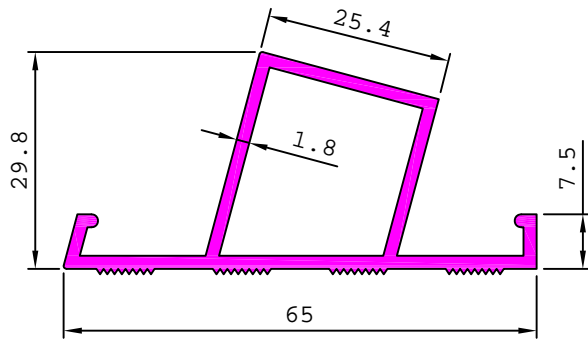

22520

1.038 kg/m

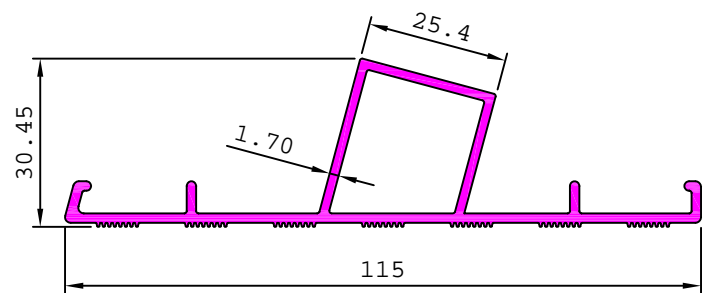

22562

0.516 kg/m

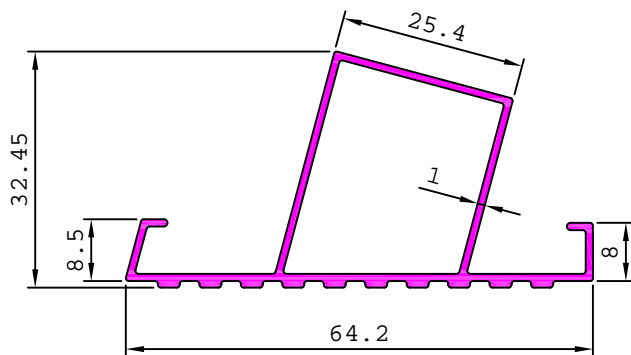

22566

0.692 kg/m

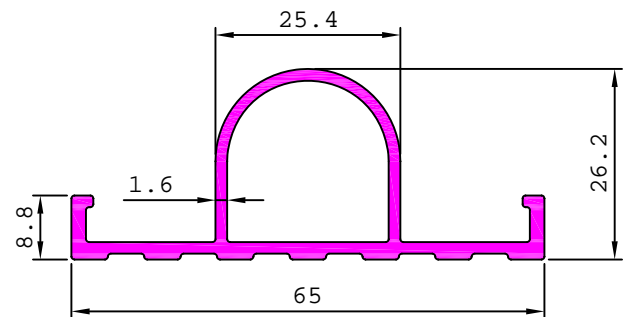

22582

0.510 kg/m

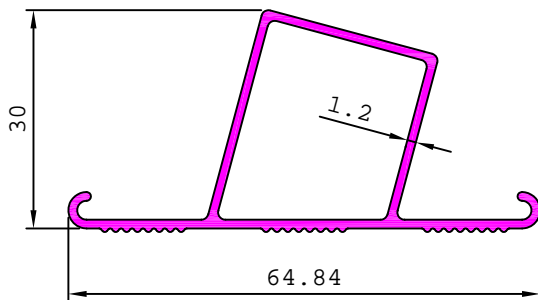

22595

0.476 kg/m

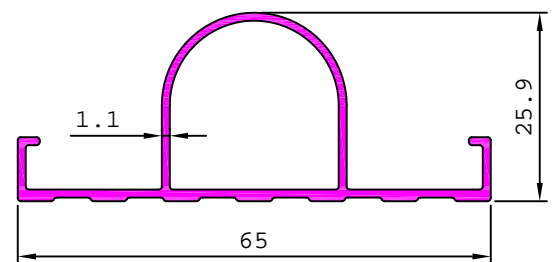

LADDERS

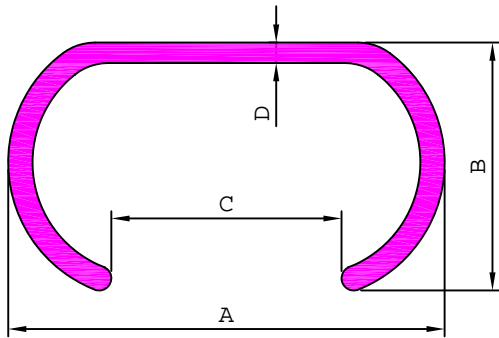

SL. No.	Section No.	A	B	C	D	Weight kg/m
1	22552	62.00	28.00	40.00	1.10	0.335
2	22544	66.65	31.75	41.30	1.20	0.410
3	22511	66.65	31.75	41.30	1.81	0.607
4	22571	66.65	31.75	41.30	2.20	0.732
5	22503	66.65	31.75	41.30	2.54	0.837
6	22504	66.67	31.75	41.27	3.18	1.046
7	22505	66.68	31.75	47.00	4.00	1.247
8	S6342	66.00	31.50	40.20	2.50	0.829

22513

0.976 kg/m

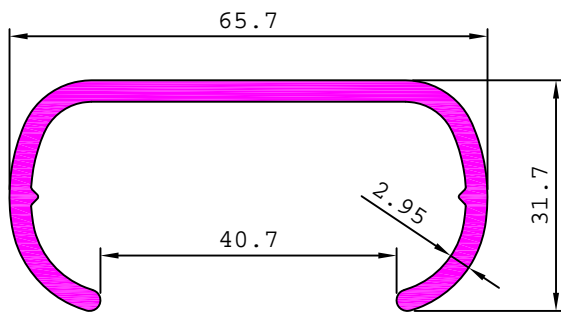

22516

1.009 kg/m

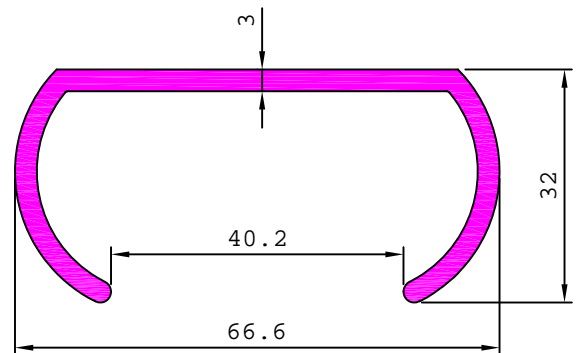

22524

0.668 kg/m

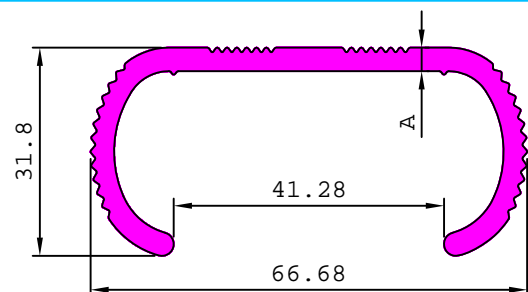
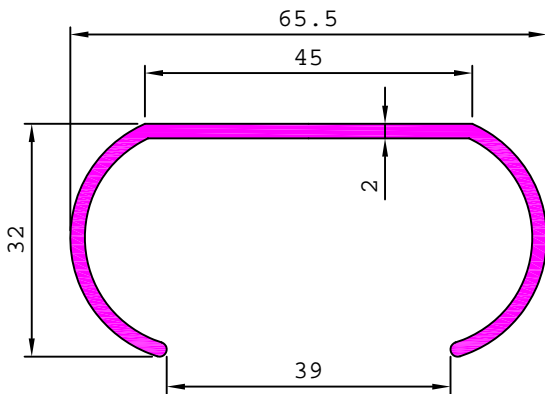

SL. No.	Section No.	A	Weight kg/m
1	22583	3.20	0.985
2	22575	3.60	1.105

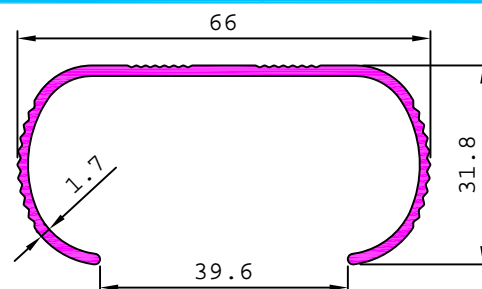

SL. No.	Section No.	A	Weight kg/m
1	22573	1.70	0.544
2	22574	2.50	0.800

LADDERS

22515

0.535 kg/m

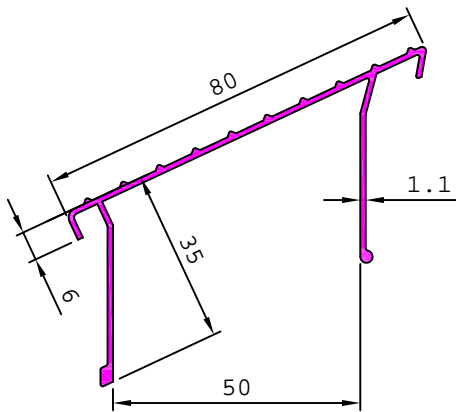

22526

0.506 kg/m

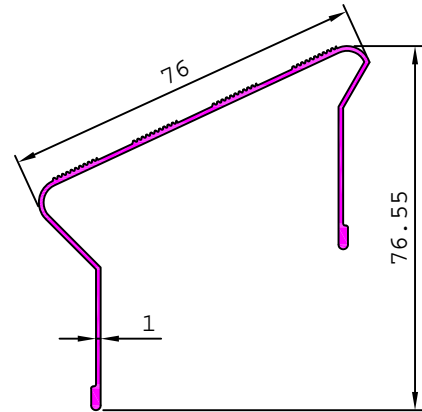

22525

0.486 kg/m

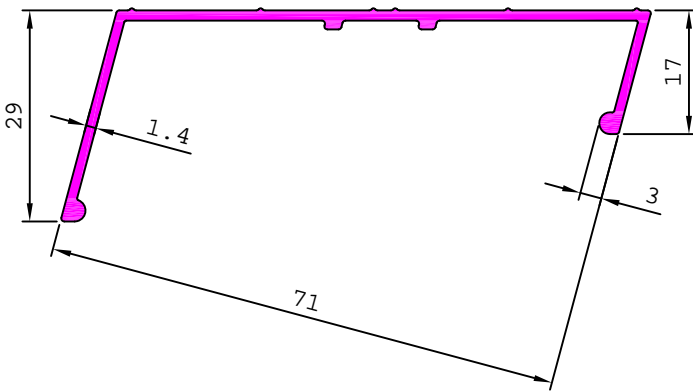

22547

0.875 kg/m

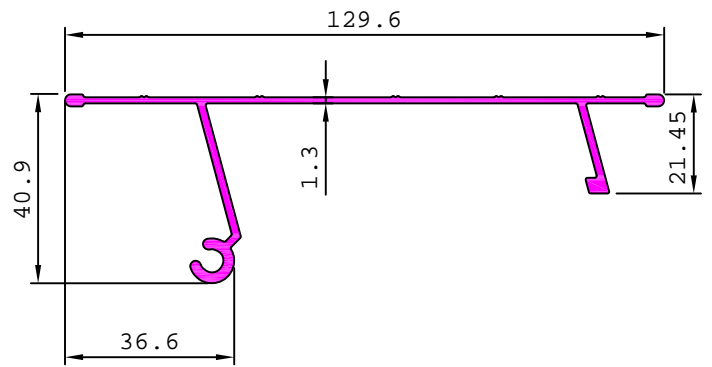

22550

1.296 kg/m

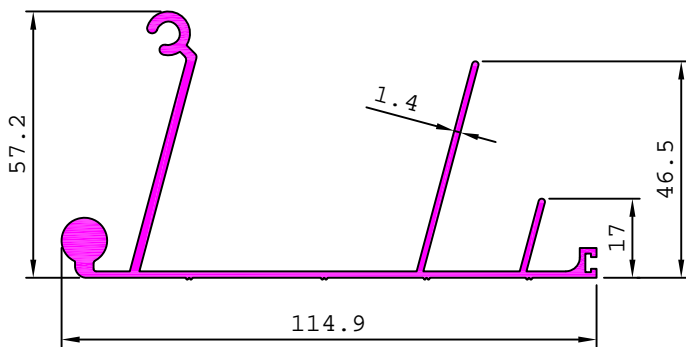

22551

1.103 kg/m

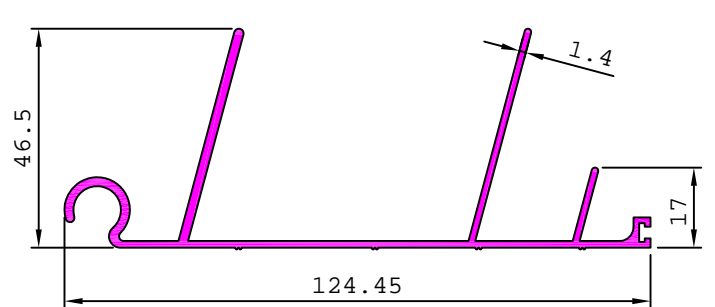

22553

0.287 kg/m

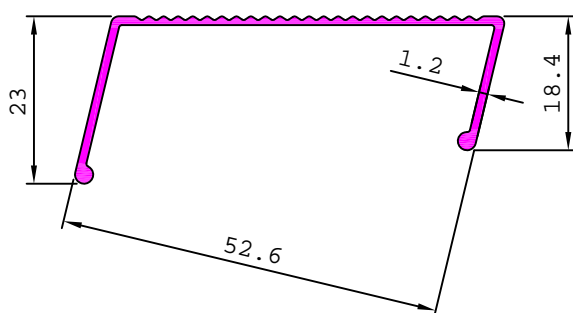

22565

0.328 kg/m

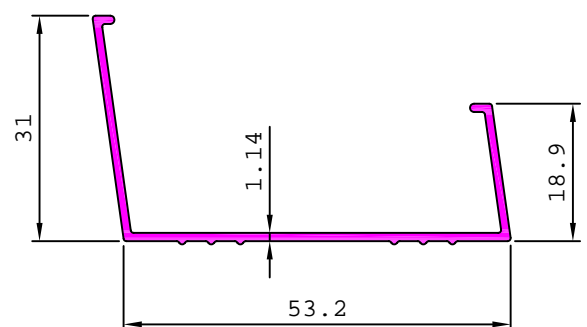

LADDERS

22568

0.594 kg/m

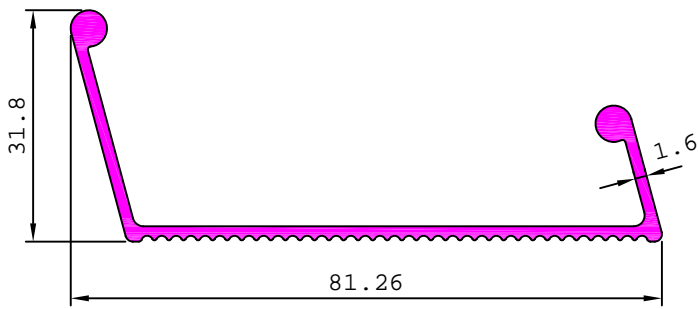

22570

0.609 kg/m

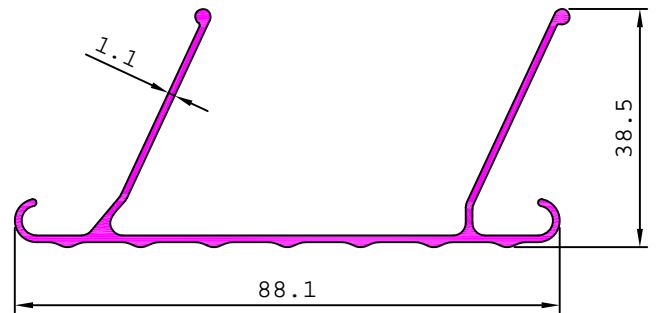

22558

0.777 kg/m

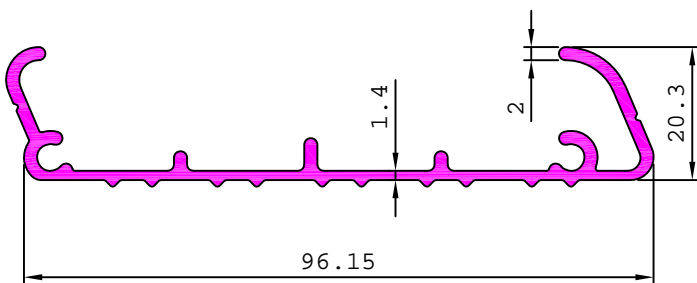

22507

0.673 kg/m

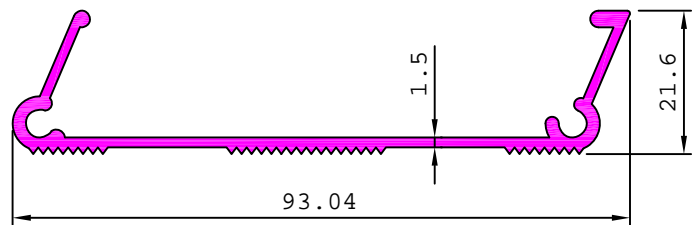

22581

0.404 kg/m

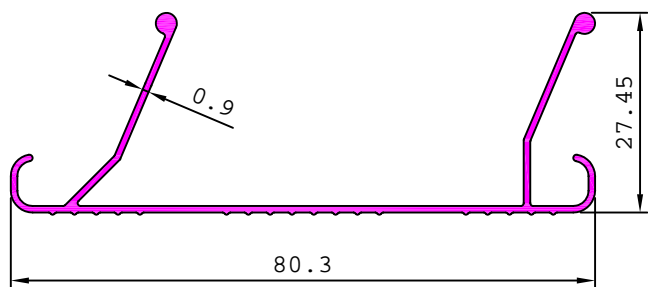

22588

0.681 kg/m

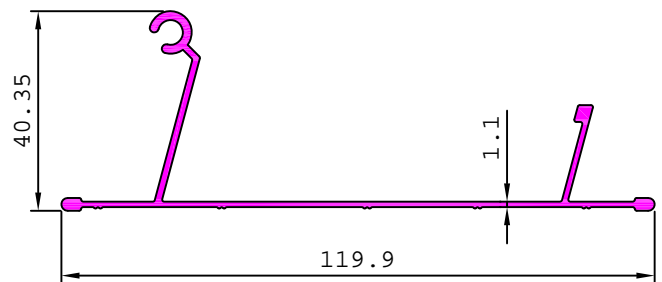

LADDERS

22506

0.767 kg/m

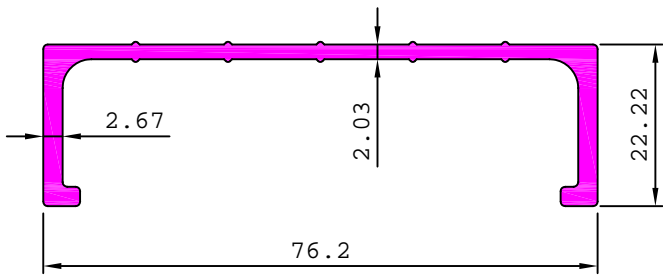

22508

0.662 kg/m

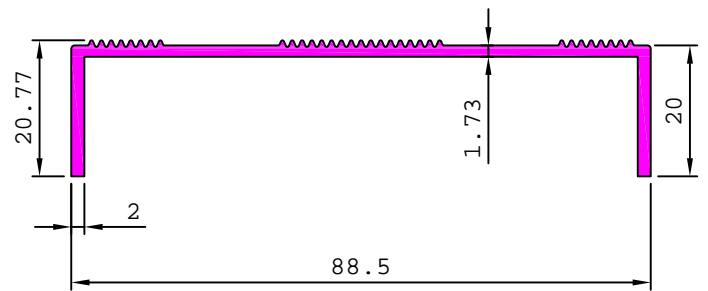

22512

0.575 kg/m

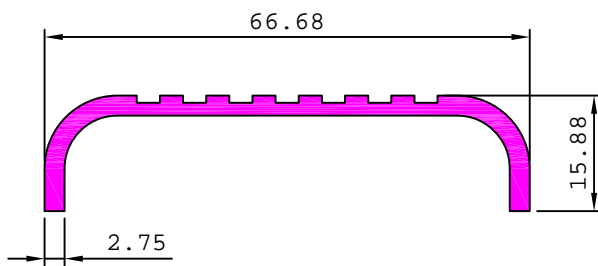

22548

0.355 kg/m

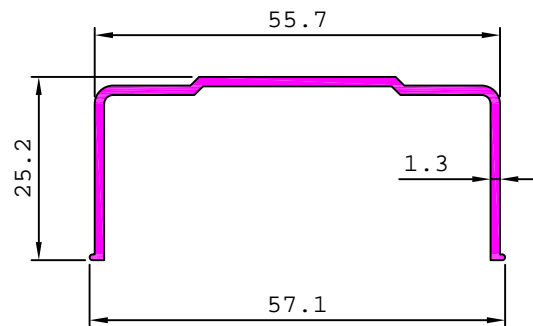

22563

0.327 kg/m

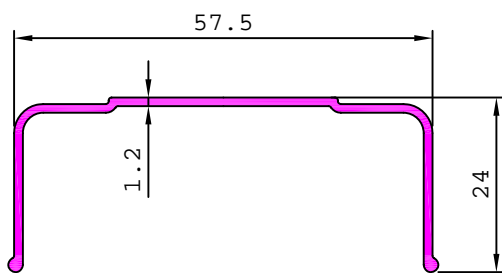

22567

0.640 kg/m

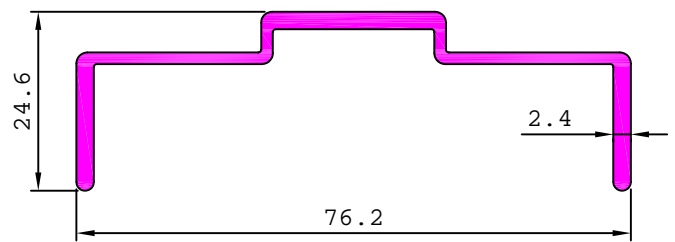

22572

0.739 kg/m

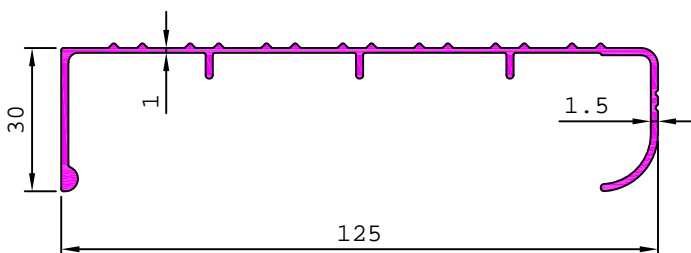

22584

0.793 kg/m

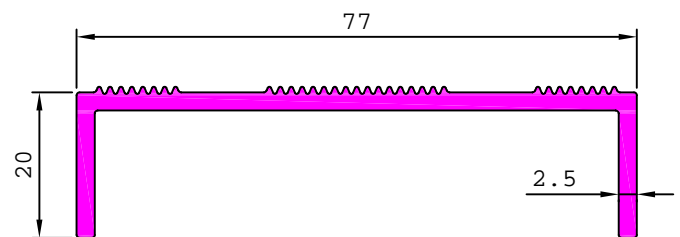

LADDERS

22587

0.415 kg/m

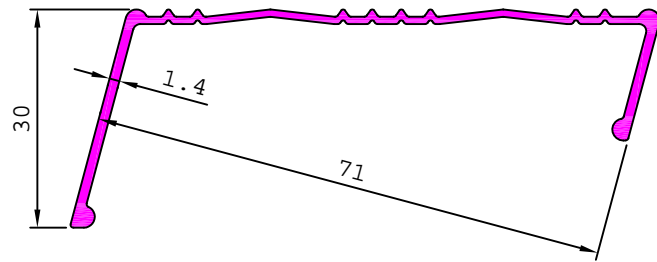

22589

0.398 kg/m

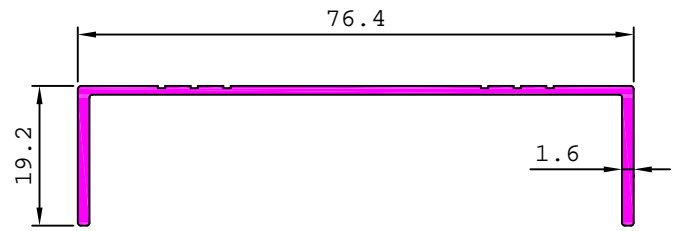

22518

0.871 kg/m

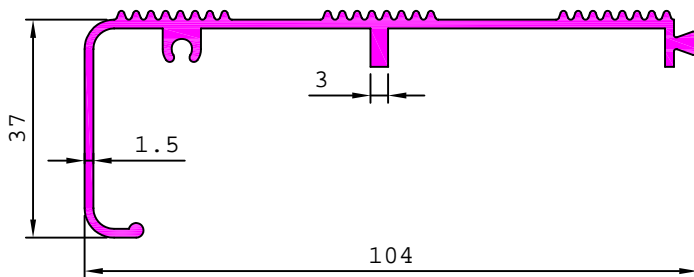

22519

0.659 kg/m

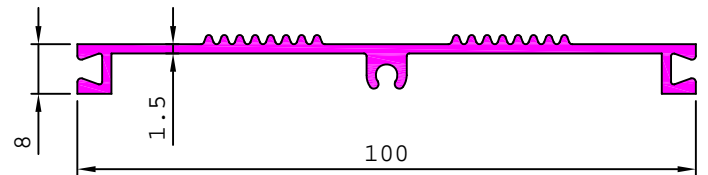

22579

0.661 kg/m

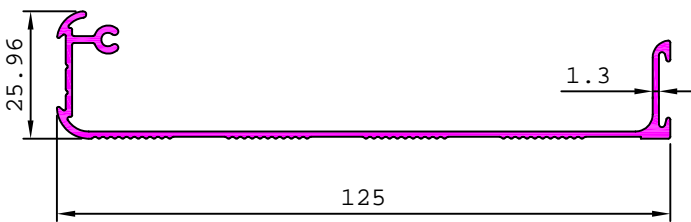

22580

0.666 kg/m

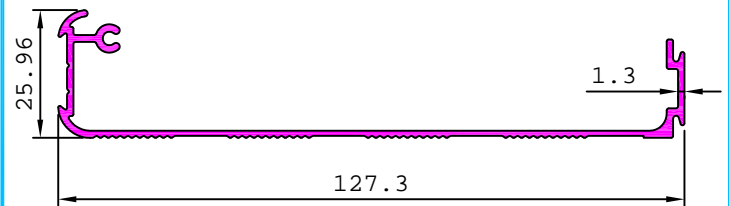

22593

0.816 kg/m

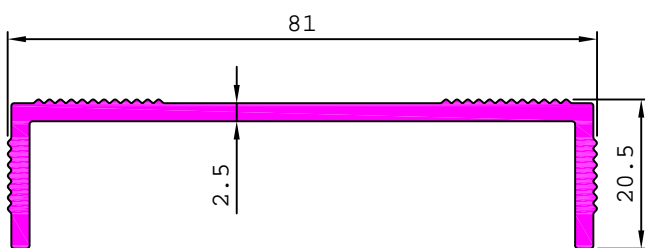

LADDERS

22523

1.099 kg/m

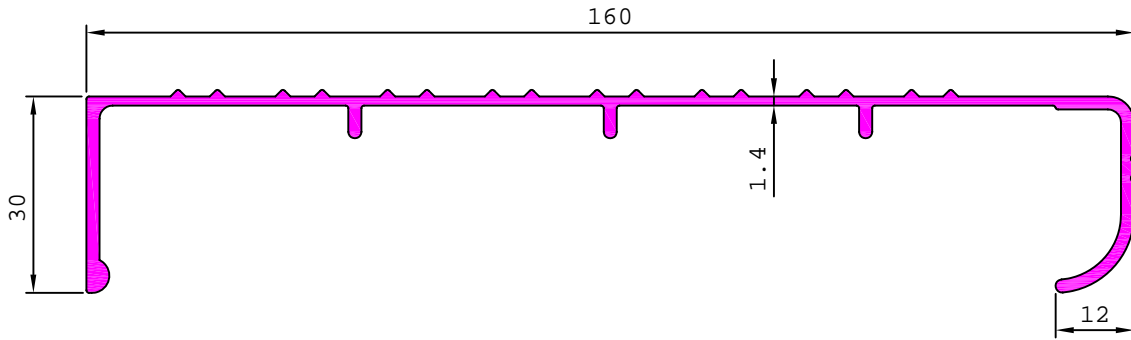

22591

1.538 kg/m

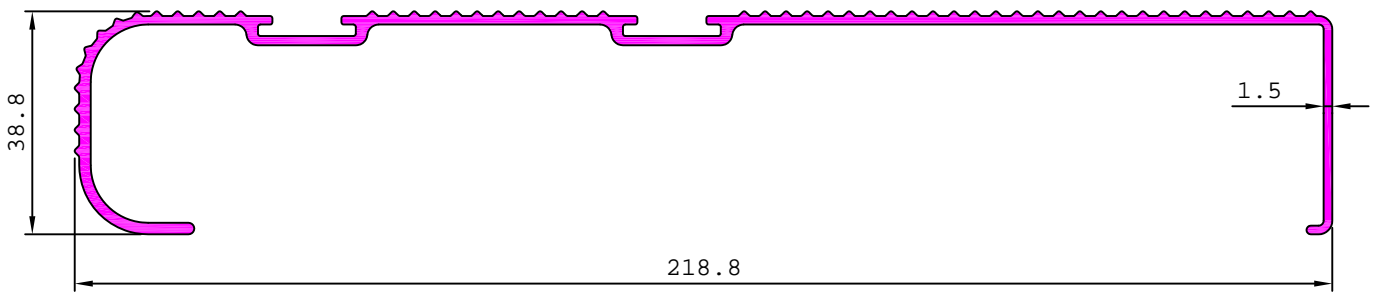

22594

1.551 kg/m

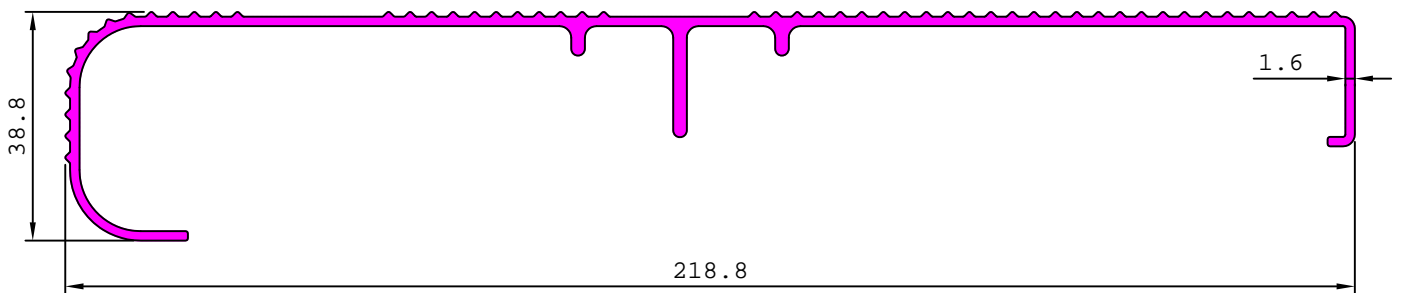

22521

1.251 kg/m

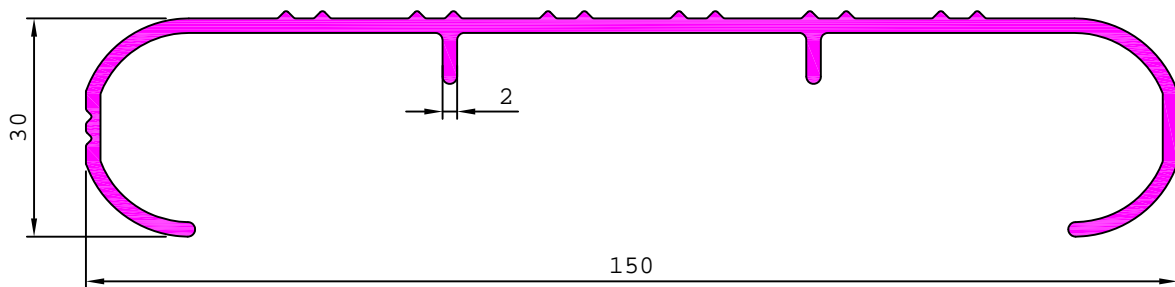

LADDERS

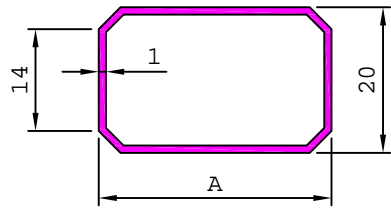

38577

0.448 kg/m

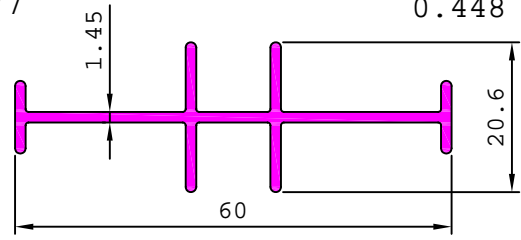

SL. No.	Section No.	A	Weight kg/m
1	22501	50.00	0.350
2	22502	32.00	0.252

S5451

0.533 kg/m

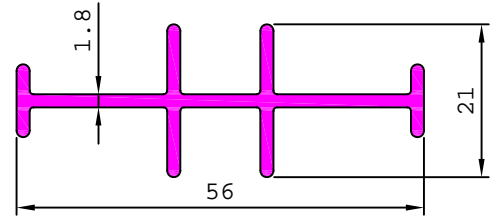

22577

0.263 kg/m

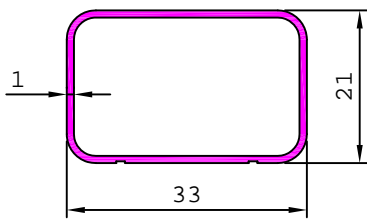

22578

0.349 kg/m

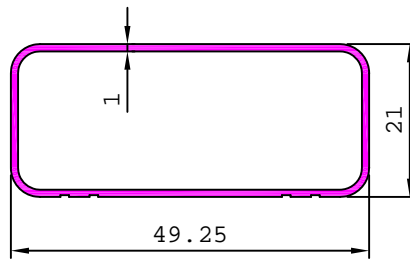

24491

0.270 kg/m

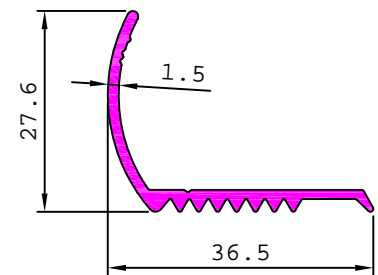

22546

0.371 kg/m

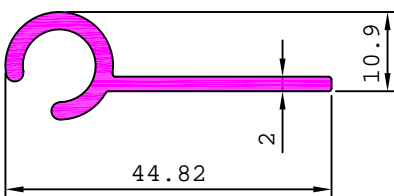

22590

0.271 kg/m

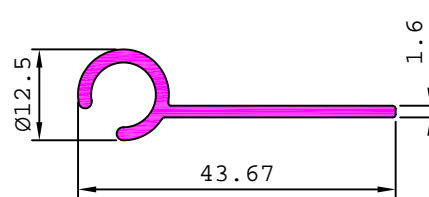

22564

0.133 kg/m

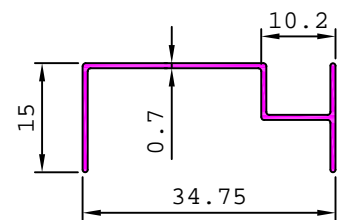

22522

0.536 kg/m

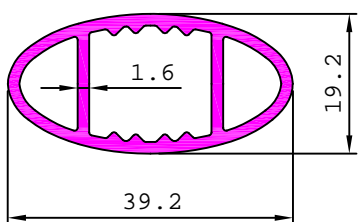

22545

0.197 kg/m

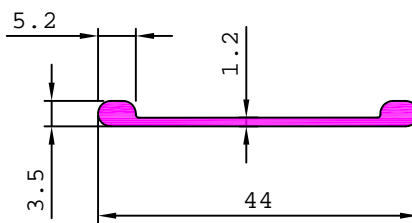

22559

0.345 kg/m

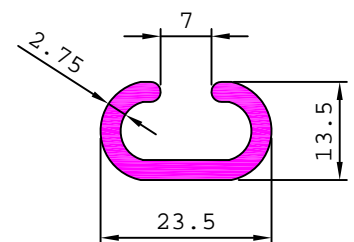

MATCHING WITH 22588

LADDERS

22576

0.441 kg/m

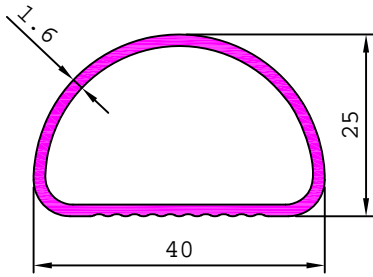

LADDERS

22586

17.378 kg/m

222.31

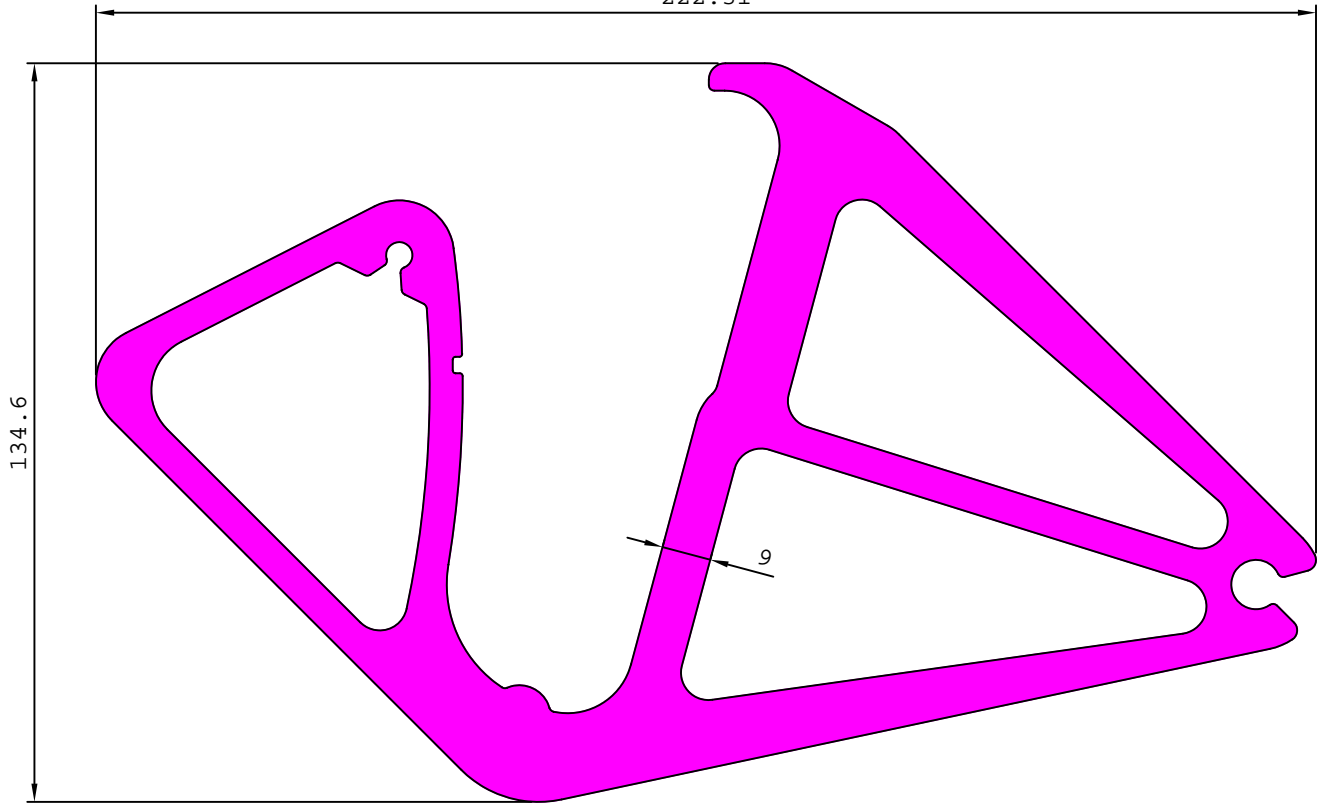

22600

6.504 kg/m

